

VELUX®

DSD/DSH/RSD/RSH



C  **US LISTED**
Accessory Electric Blinds



VAS 452177-0809

ENGLISH: ⚠ **Important information:** Read the instructions in full before installation. To ensure correct function and safe operation of the product, it is important to follow these instructions fully. Keep the instructions for future reference and hand them over to any new user.

ESPAÑOL: ⚠ **Información importante:** Lea estas instrucciones en su totalidad antes de comenzar. Para garantizar un funcionamiento correcto y seguro del producto, es importante seguirlas cuidadosamente. Consérvelas para su uso posterior y entréguelas al consumidor final.

FRANÇAIS : ⚠ **Information importante :** Lire attentivement la totalité de la notice avant l'installation. Pour un fonctionnement correct et une manœuvre sûre du produit, il est important de suivre avec attention cette notice. Conserver la notice pour un éventuel besoin ultérieur et le remettre à tout nouvel utilisateur.

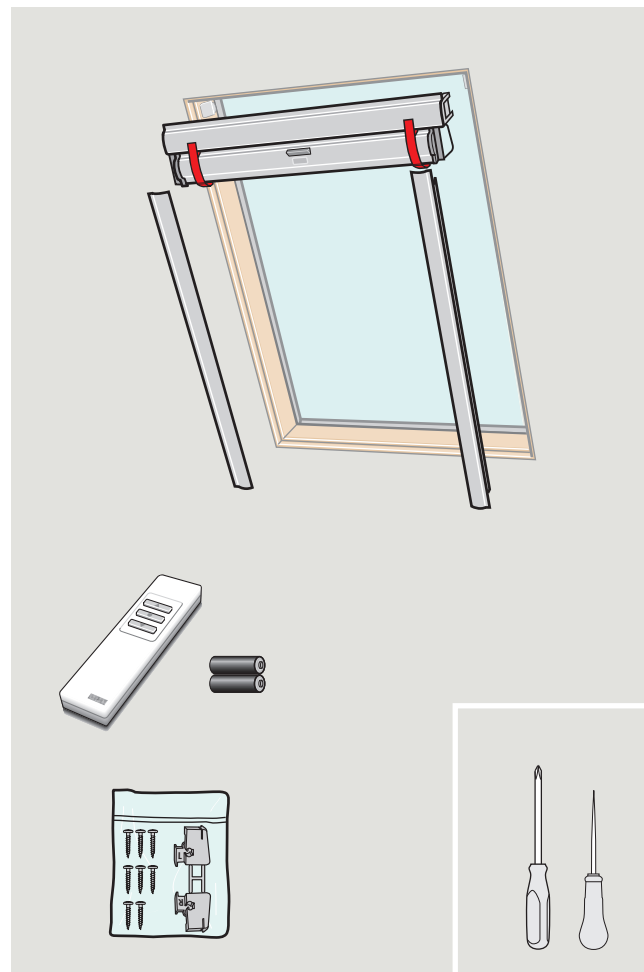

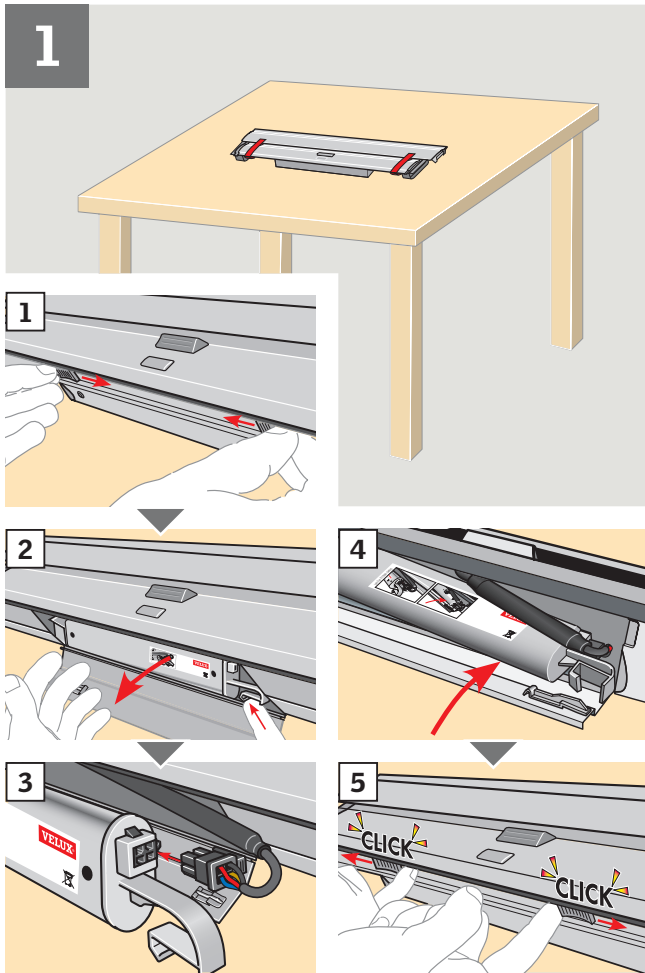

4 VELUX

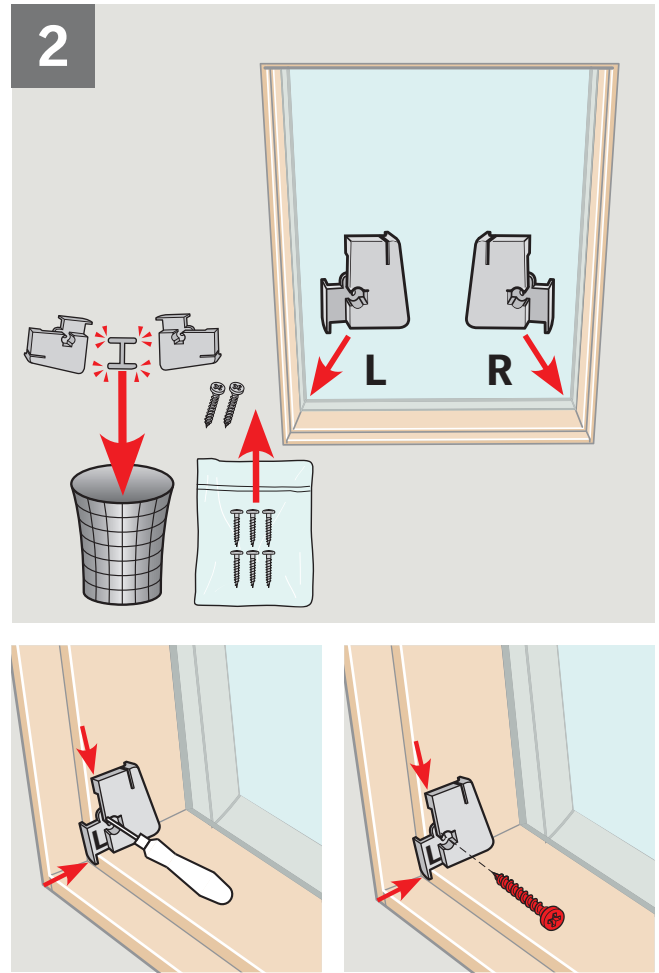

VELUX 5

3

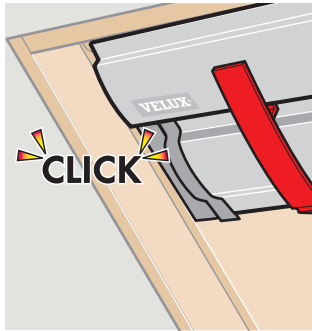
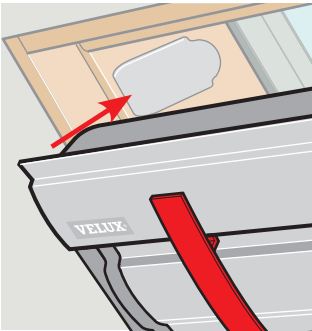
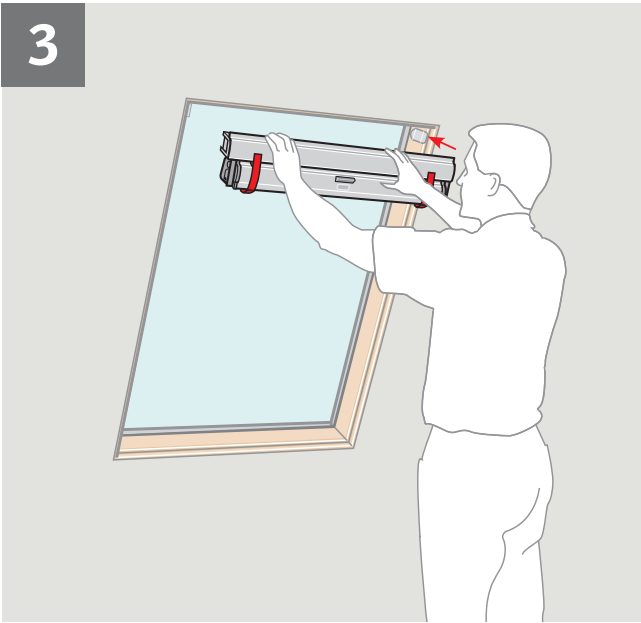

6 VELUX

4

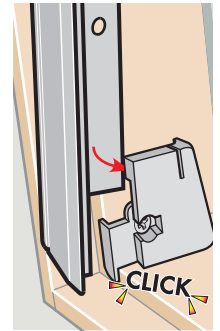
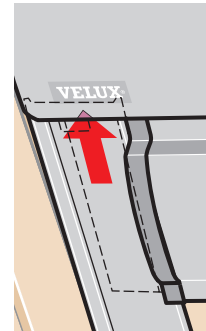
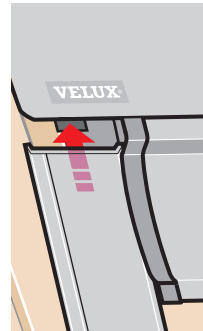
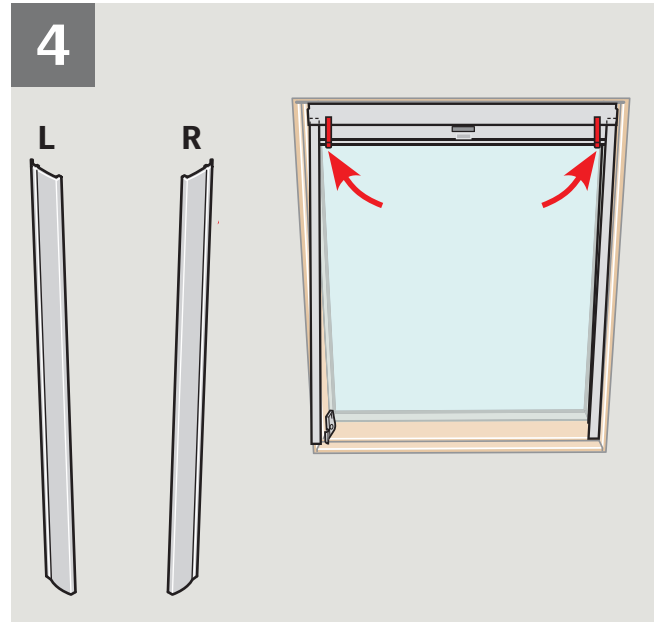

VELUX 7

5

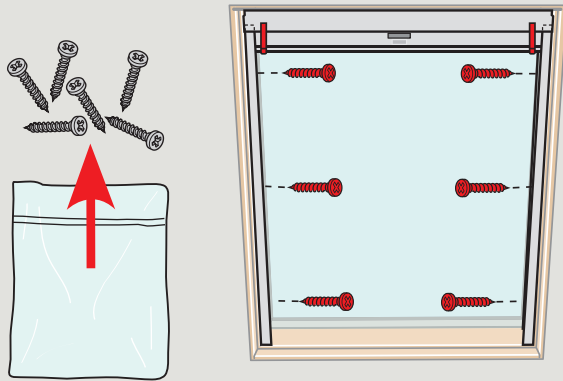

6

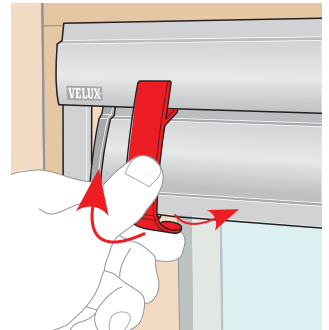
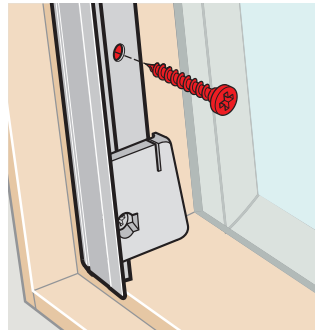
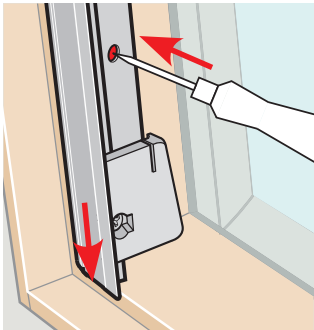
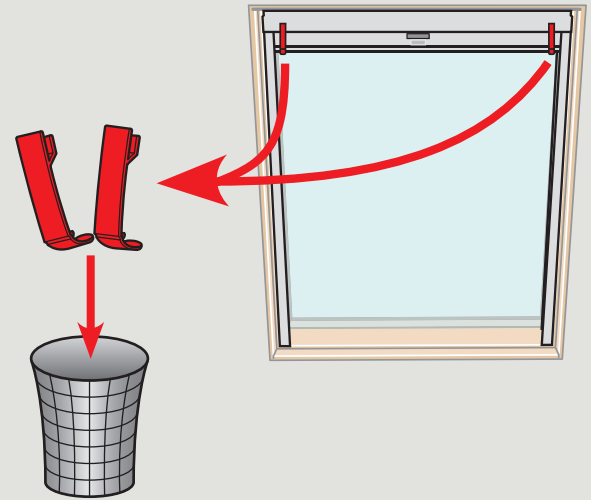

7

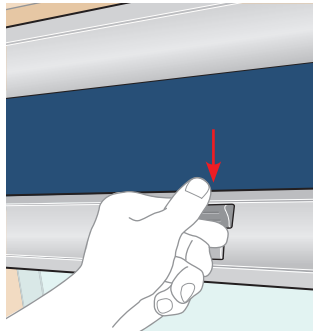
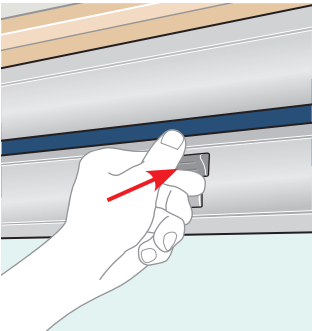
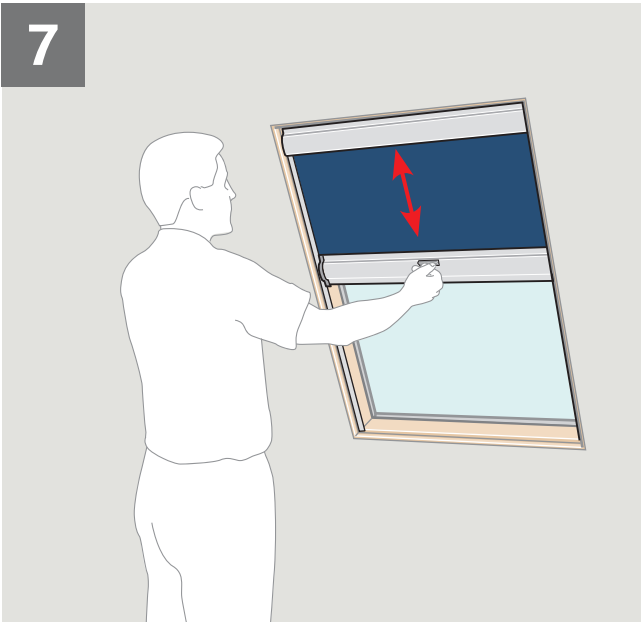

10 VELUX

8

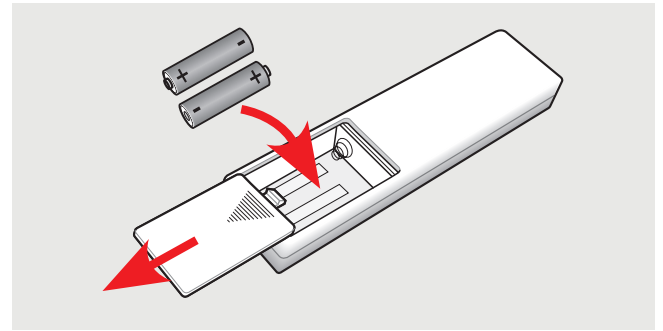
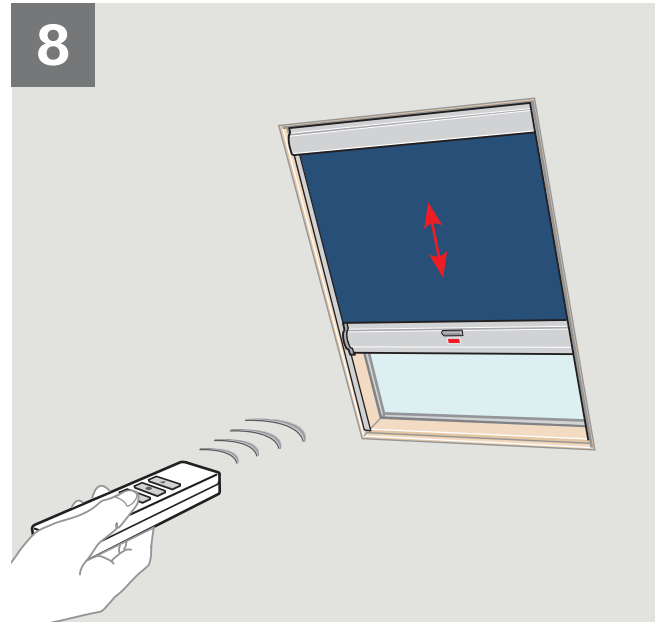

VELUX 11

9

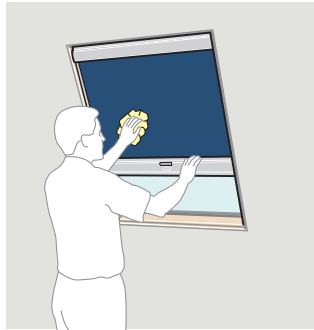
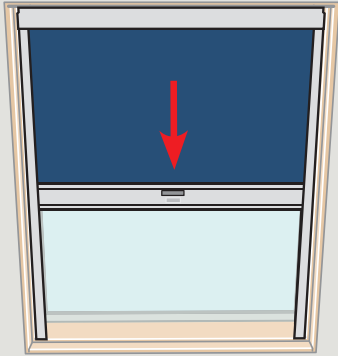

The logo consists of the word "VELUX" in a bold, white, sans-serif font, with a registered trademark symbol (®) to its upper right. The text is centered within a solid red rectangular background.

- USA:** VELUX America Inc.
1-800-88-VELUX
- CDN:** VELUX Canada Inc.
1 800 88-VELUX (888-3589)
- AUS:** VELUX Australia Pty. Ltd
1300 859 856
- NZ:** VELUX New Zealand Ltd.
09-6344 126
- J:** VELUX-Japan Ltd.
03(3478)81 41

www.velux.com